

# Cobble

Desktop module



# Cobble

Desktop module



Product Builder



White/ Anodised



Grey Anodised



Black/ Anodised



Black/ Black



White/ White

Cobble provides complete customisable power and data in a stylish, versatile and space saving device. In addition to fixing to desks Cobble also easily attaches to vertical surfaces. Due to our UK design & manufacture even the most complex configurations can be created and delivered in ten working days, subject to component availability.

- All products PAT tested
- BS 5733 certified
- Short lead times
- Fast installation
- Fire rated plastics

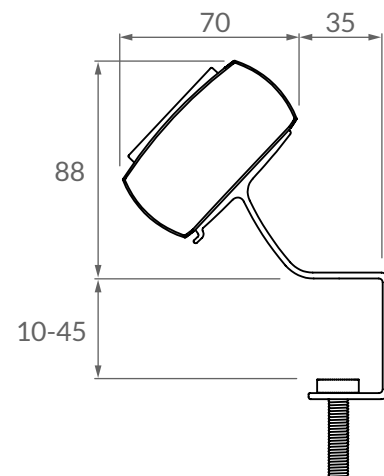

\*All measurements in mm  
Other attachments available

# Module Outlets

Above, in and under desk

Compatible with:  
Boulder, Cobble, Pebble, Median, Summit  
Cove, Cove Plus, Mirage, Surface  
Slimline, Sub

## Power

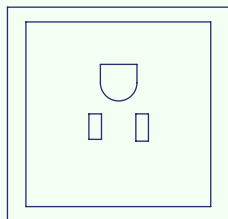

Type B (USA)

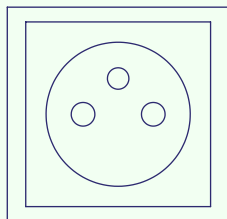

Type E (French)

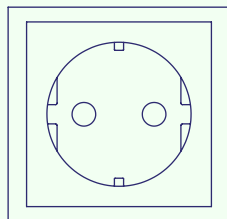

Type F (Schuko)

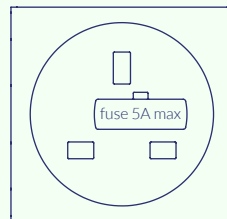

Type G (UK) Fused

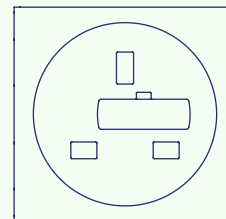

Type G (UK) Unfused

## USB Power

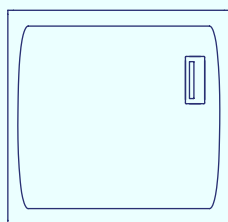

USB-A Single

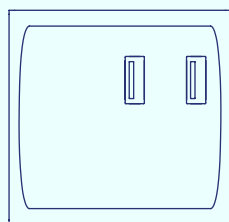

USB-A Double

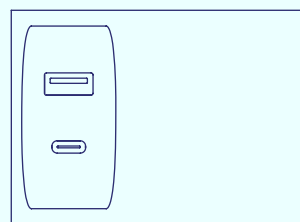

USB-A + USB-C

## Switches

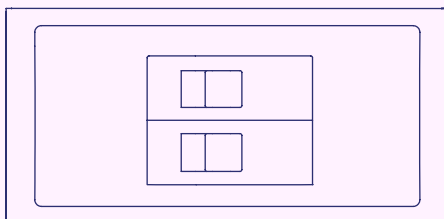

Double/ Single MCB

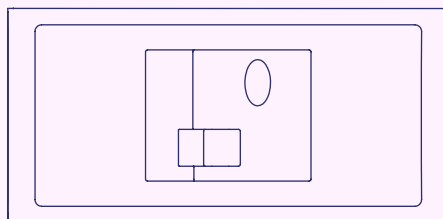

RCBO

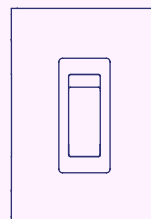

Master Switch

## Data & AV Keystone

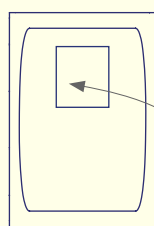
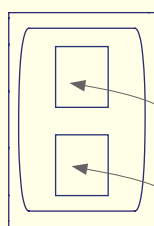

Faceplates can be fitted with either 1 or 2 keystones.

Common keystone outlet options below.

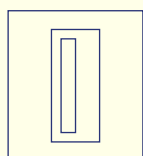

USB-A

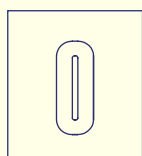

USB-C

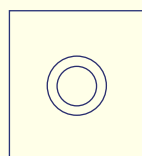

Audio

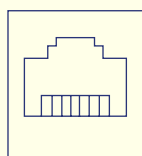

Data

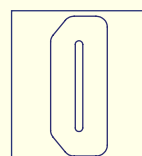

HDMI

## Custom Options

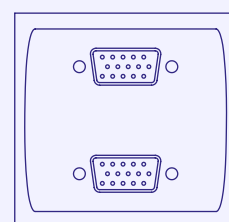

SVGA Single/ Double

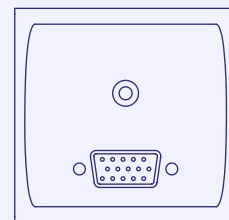

SVGA + Audio

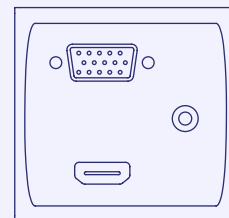

SVGA + Audio + HDMI

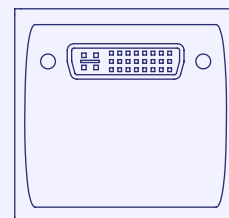

DVI Single

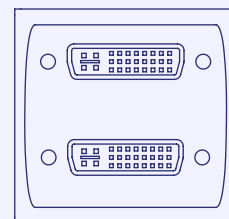

DVI Double