

# Eyelet Round

In desk module



# Eyelet Round

In desk module



Grey/ Stainless Steel



Black/ Stainless Steel



Black/ Black



White/ White



White/ Stainless Steel

Fitting a standard  $\text{Ø}80\text{mm}$  cut out - the Eyelet provides a selection of power and data outlets in an aesthetically pleasing in-desk unit. The high quality stainless steel face plate can be personalised to a range of colours and finishes. This innovative product makes use of the frequently vacant cable ports within desks.

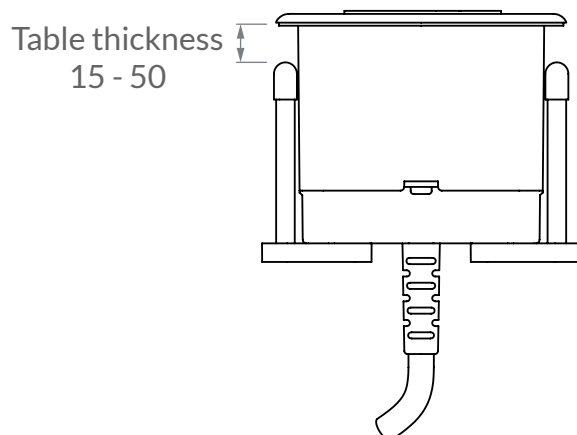
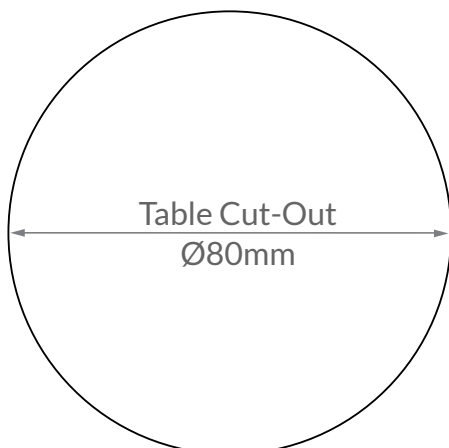

# Eyelet Outlets

## Keystone options

### Shape Options

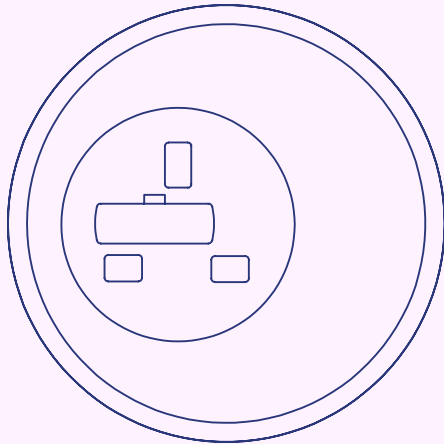

Eyelet Round

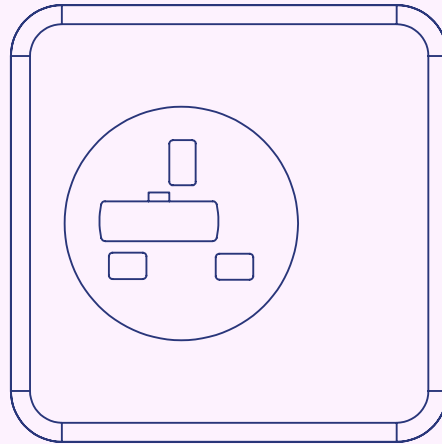

Eyelet Square

### Power

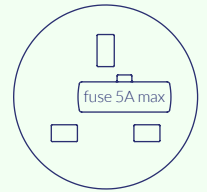

Type G (UK) Fused

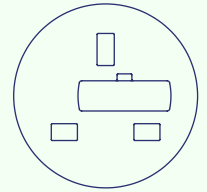

Type G (UK) Unfused

### Number of Keystone Outlets

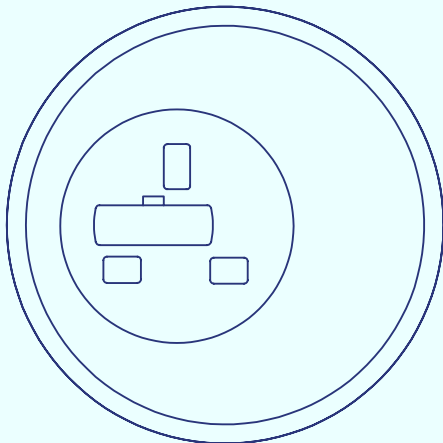

No Outlets

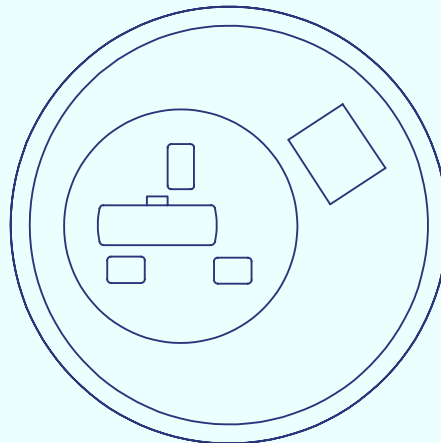

One Outlet

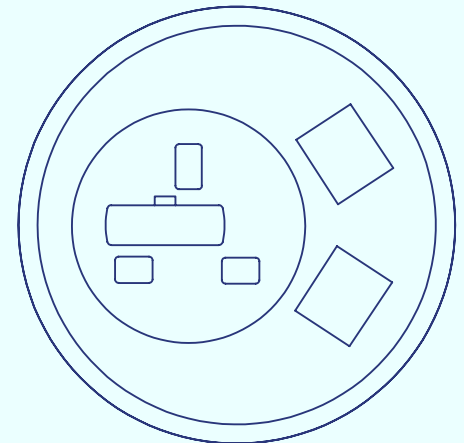

Two Outlets

### Data & AV Keystone

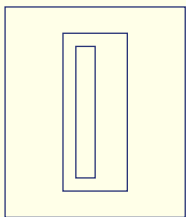

USB-A

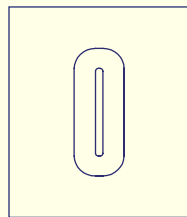

USB-C

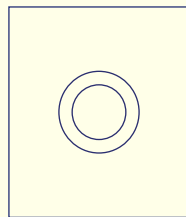

Audio

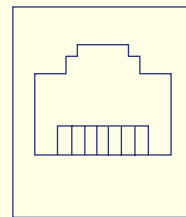

Data

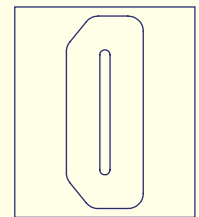

HDMI