

Mirage

In desk module



Mirage

In desk module



Product Builder



A power & comms unit with an extraordinarily low profile which fits flush to table top. As well as the power, data & AV options being customisable (sockets can be orientated to service users on both sides) the colour/finish of each component including the all metal body and surround can also be selected by the client. Thin profile makes it suitable for panel mounting and soft furnishing.

*All measurements in mm

- Slim line Bezel
- All products PAT tested
- Short lead times, fast installation
- Fire rated, BS 5733 certified

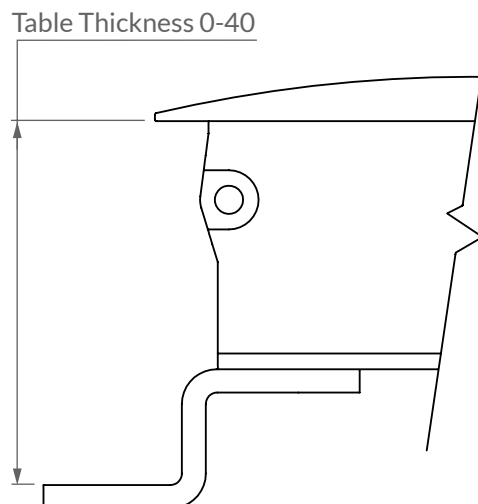

*All measurements in mm

Module Outlets

Above, in and under desk

Compatible with:
Boulder, Cobble, Pebble, Median, Summit
Cove, Cove Plus, Mirage, Surface
Slimline, Sub

Power

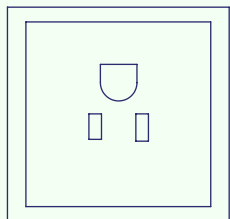

Type B (USA)

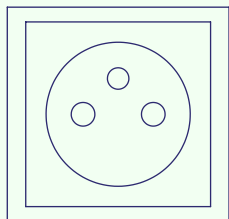

Type E (French)

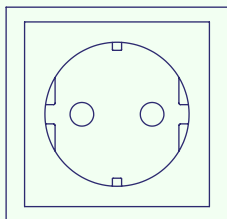

Type F (Schuko)

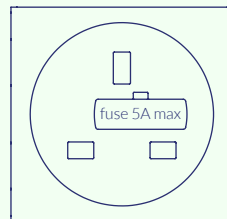

Type G (UK) Fused

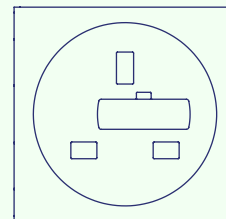

Type G (UK) Unfused

USB Power

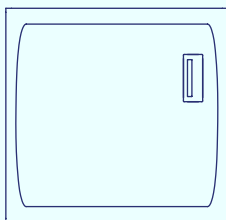

USB-A Single

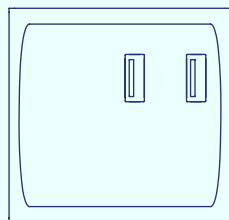

USB-A Double

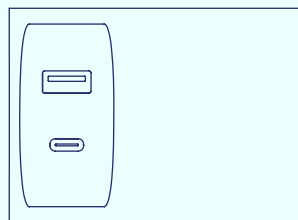

USB-A + USB-C

Switches

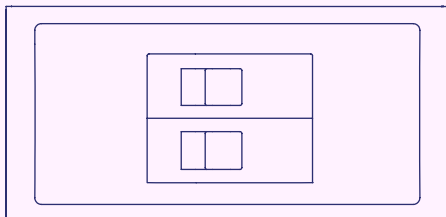

Double/ Single MCB

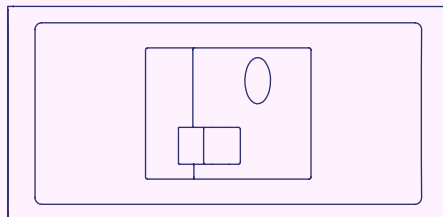

RCBO

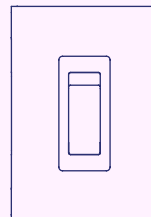

Master Switch

Data & AV Keystone

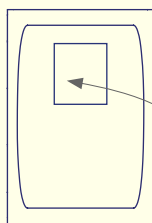
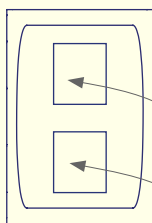

Faceplates can be fitted with either 1 or 2 keystones.

Common keystone outlet options below.

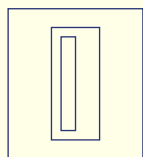

USB-A

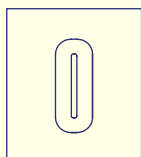

USB-C

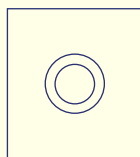

Audio

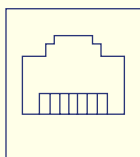

Data

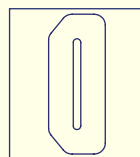

HDMI

Custom Options

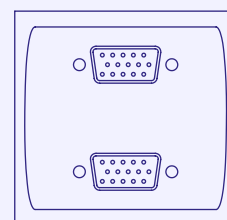

SVGA Single/ Double

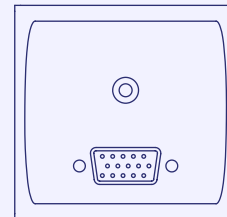

SVGA + Audio

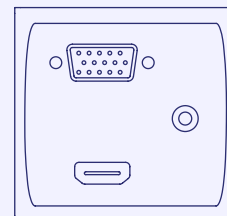

SVGA + Audio + HDMI

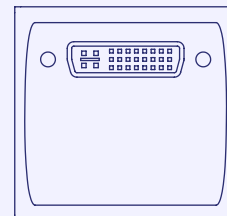

DVI Single

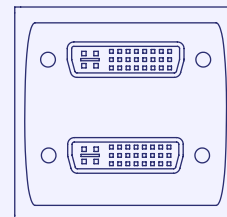

DVI Double