

# Boulder

Desktop module



# Boulder

Desktop module



Product Builder



Black/ Black



Black/ Anodised



White/ White



White/ Anodised



Grey/ Anodised

Boulder presents with a robust, compact appearance and the choice of self-adhesive fixings or desk edge clamp attachment.

- All products PAT tested
- BS 5733 certified
- Short lead times
- Fast installation
- Fire rated plastics

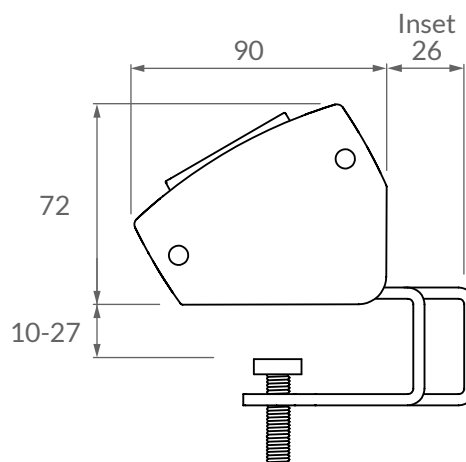

\*All measurements in mm

# Module - Outlets

Above, in and under desk

Compatible with:  
Boulder, Cobble, Pebble, Median, Summit  
Cove, Cove Plus, Mirage, Slimline, Sub

## Power

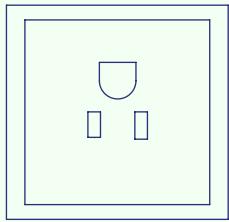

Type B (USA)

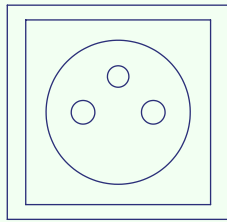

Type E (French)

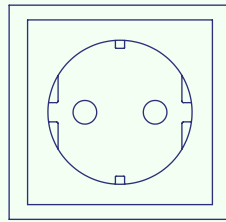

Type F (Schuko)

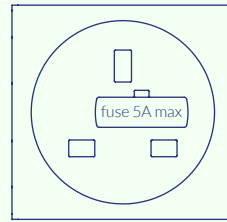

Type G (UK) Fused

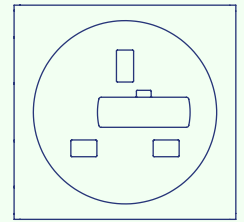

Type G (UK) Unfused

## USB Power

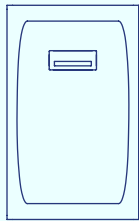

USB-A 18W

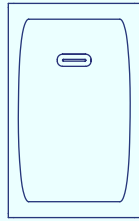

USB-C 18W

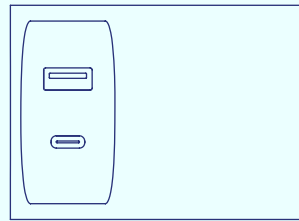

USB-A&C 45W

## AV Options

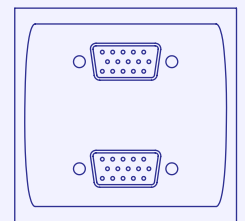

SVGA Single/ Double

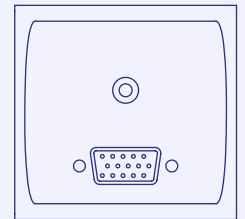

SVGA + Audio

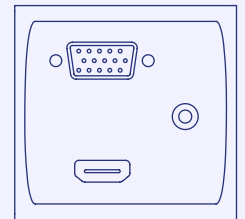

SVGA + Audio + HDMI

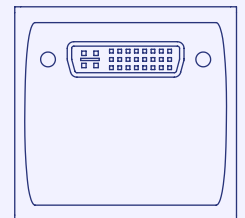

DVI Single

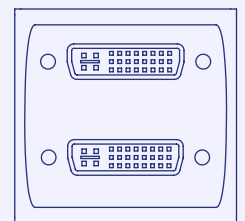

DVI Double

## Protection Devices / Switches

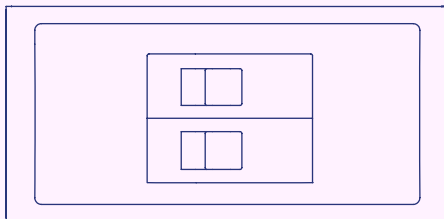

Double/ Single MCB

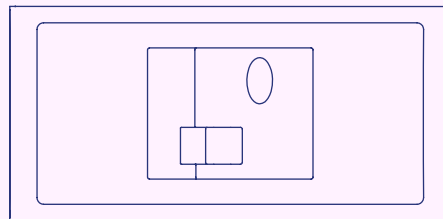

RCBO

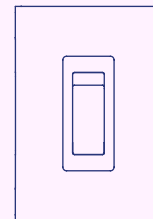

Master Switch

## Data & AV Keystone

Face plates can be fitted with either 1, 2 or 3 keystones.

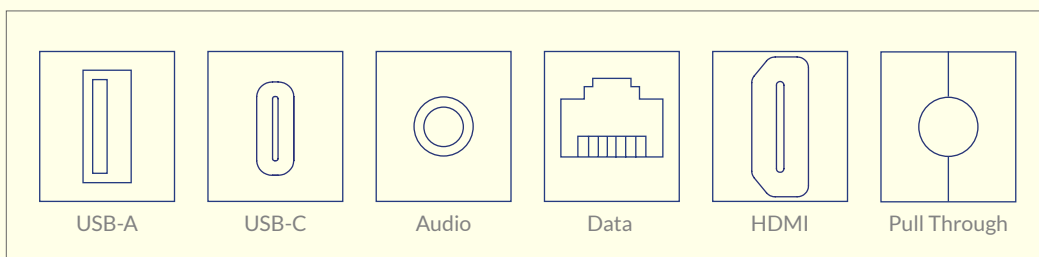
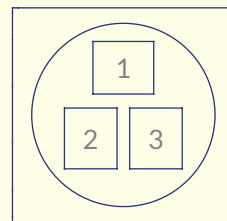
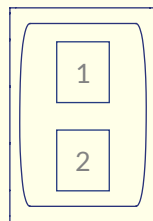
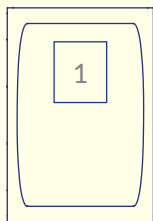

USB-A

USB-C

Audio

Data

HDMI

Pull Through